



SURROUNDS

SURROUNDS — DOORS & WINDOWS

WS1



WS1-8

Refer to page 49 for window sills options

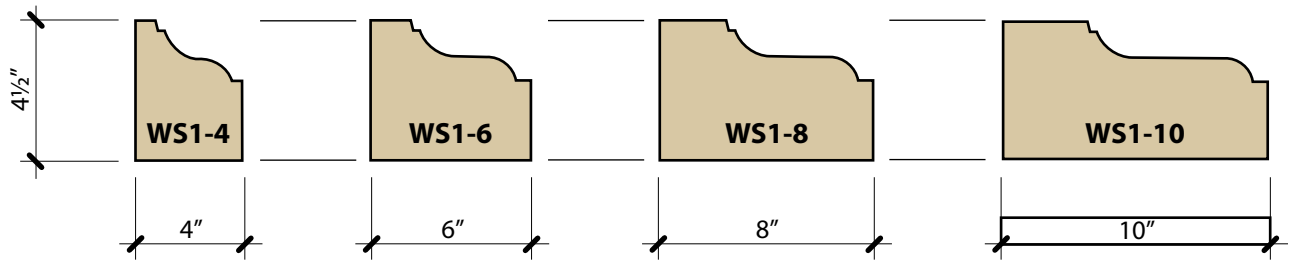

WS2

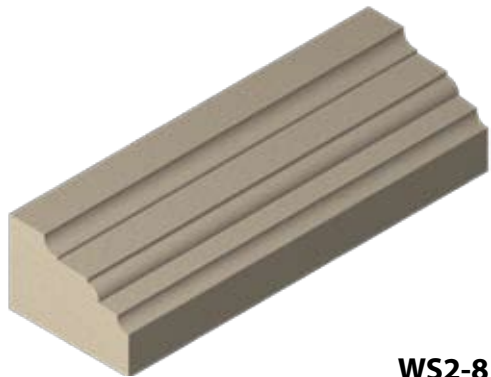
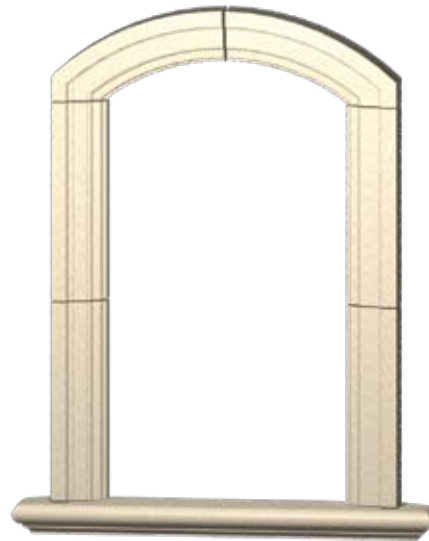

WS2-8

Refer to page 49 for window sills options

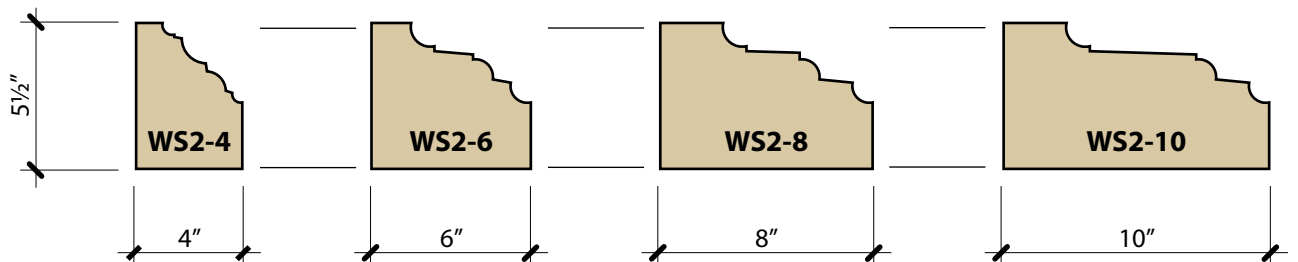

Custom sizes and styles are available. Please ask for details.

SURROUNDS — DOORS & WINDOWS

WS3

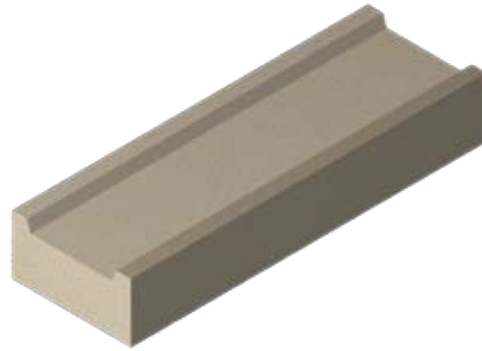
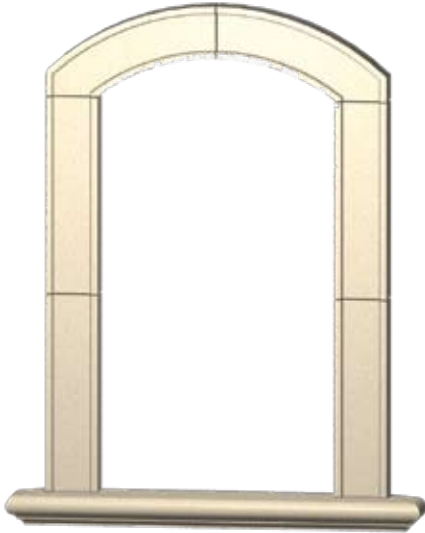

WS3-8

Refer to page 49 for window sills options

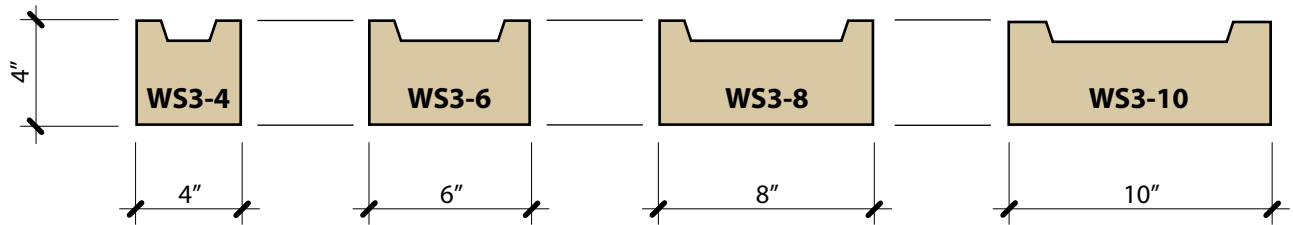

WS4

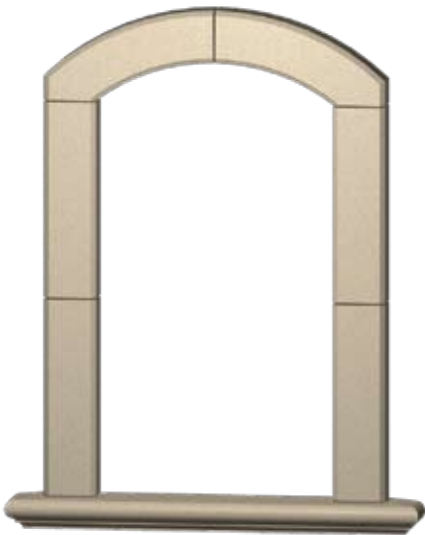

WS4-8

Refer to page 49 for window sills options

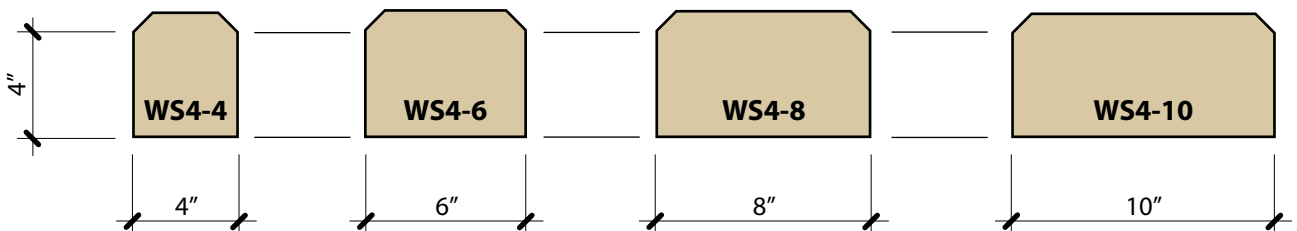

Custom sizes and styles are available. Please ask for details.

SURROUNDS — DOORS & WINDOWS

WS5



WS5-8

Refer to page 49 for window sills options

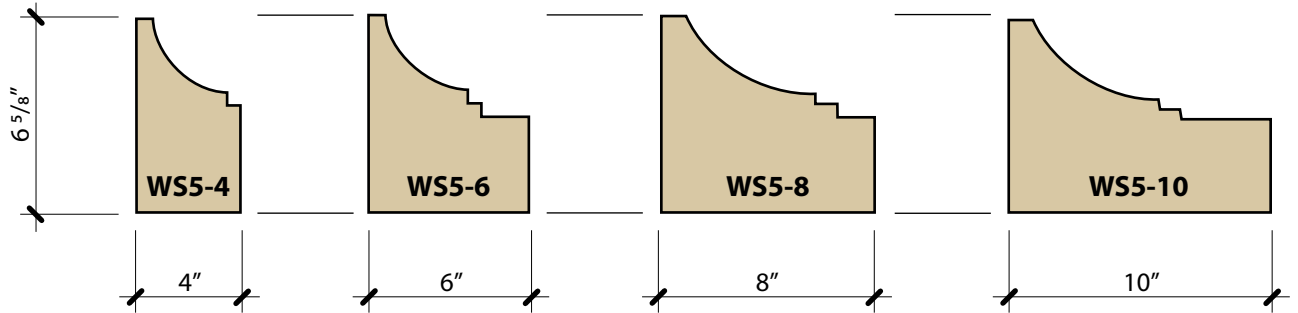

WS6



WS6-8

Refer to page 49 for window sills options

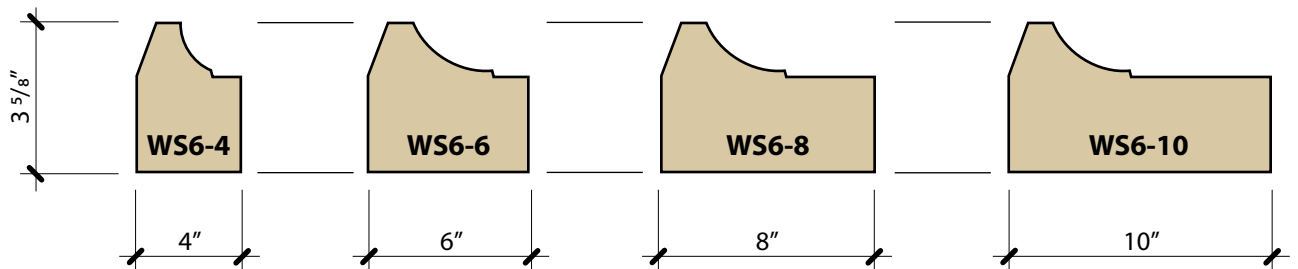

Custom sizes and styles are available. Please ask for details.

SURROUNDS — DOORS & WINDOWS

WS7

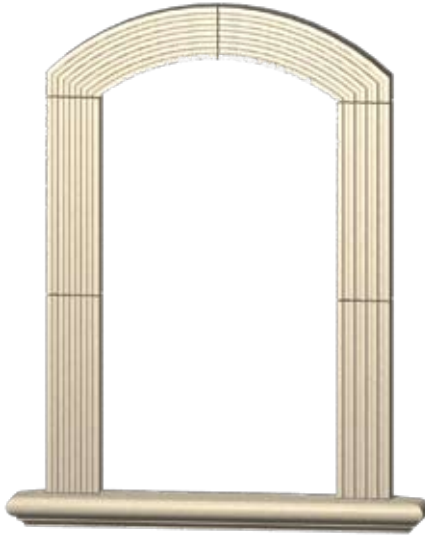

WS7-8

Refer to page 49 for window sills options

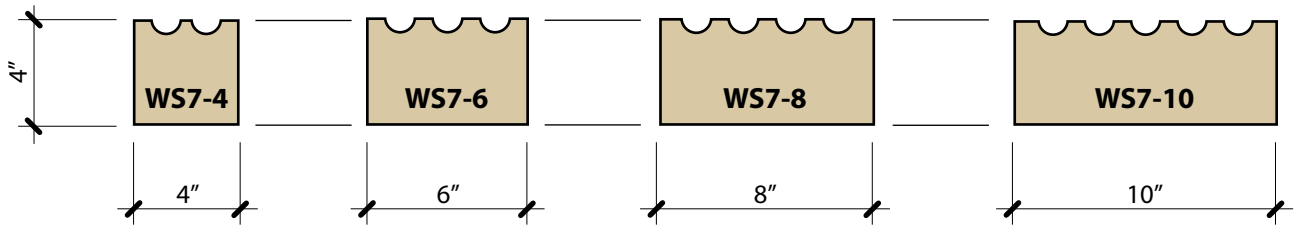

WS8

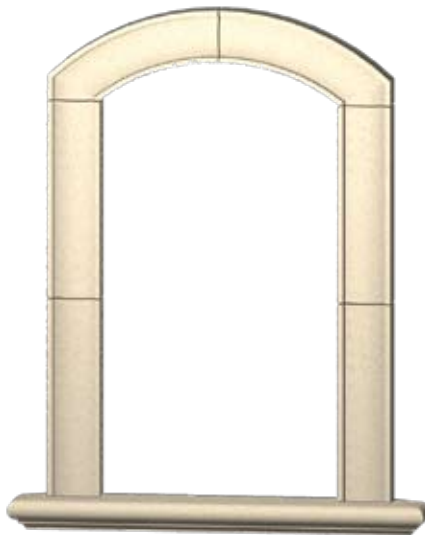

WS8-8

Refer to page 49 for window sills options

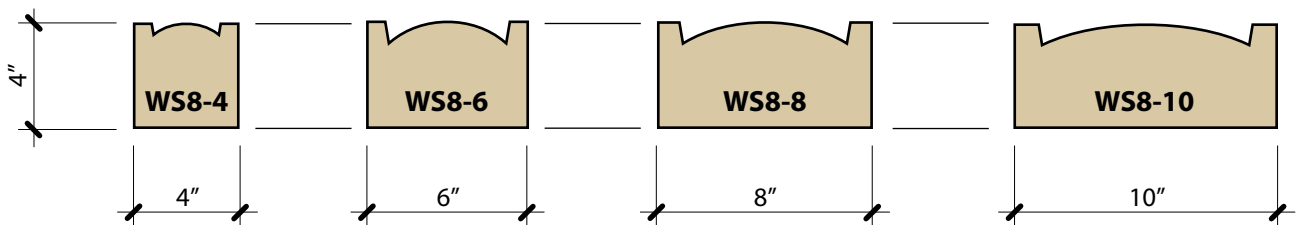

Custom sizes and styles are available. Please ask for details.

SURROUNDS — DOORS & WINDOWS

WS9



WS9-8

Refer to page 49 for window sills options

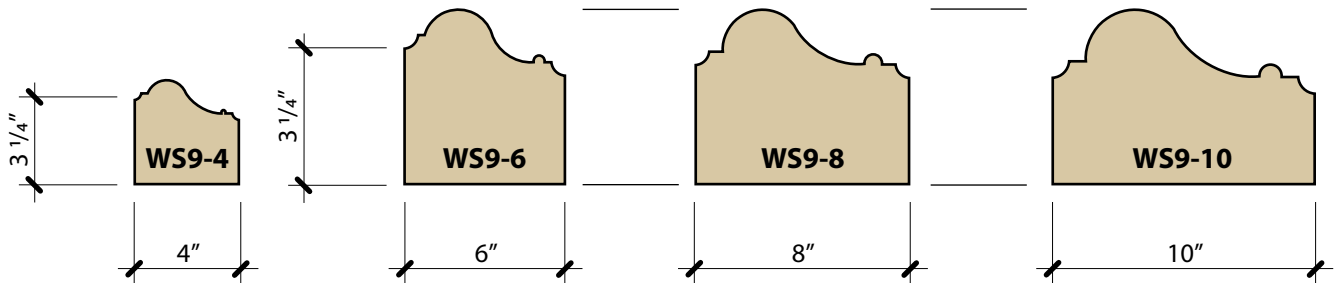

WS10



WS10-8

Refer to page 49 for window sills options

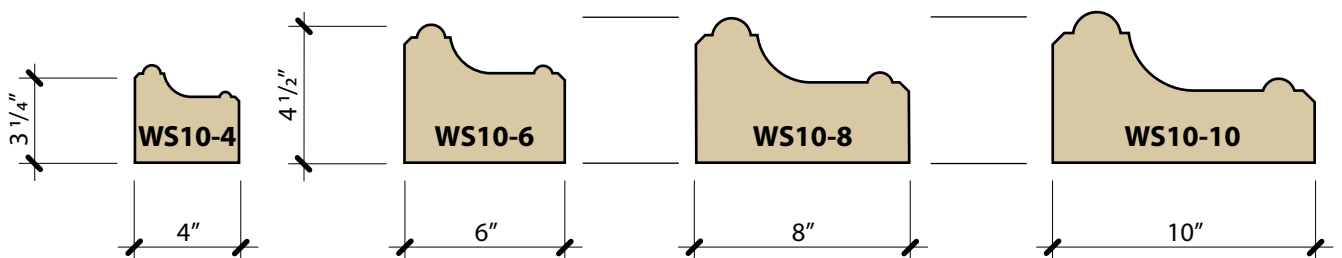

Custom sizes and styles are available. Please ask for details.

SURROUNDS — DOORS & WINDOWS

WS11



WS11-8

Refer to page 49 for window sills options

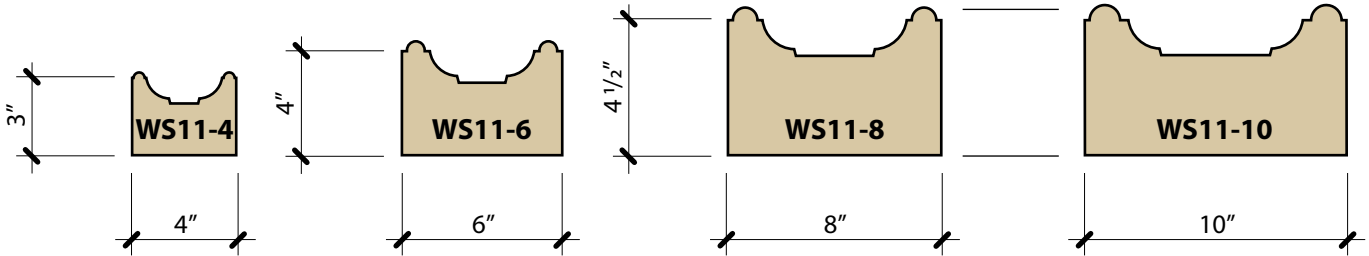

WS12



WS12-8

Refer to page 49 for window sills options

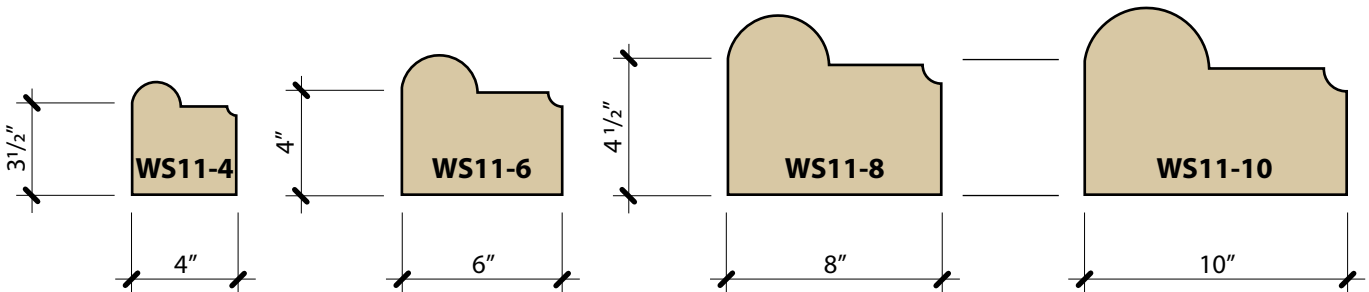

Custom sizes and styles are available. Please ask for details.

SURROUNDS — DOORS & WINDOWS

WS13



WS13-8

Refer to page 49 for window sills options

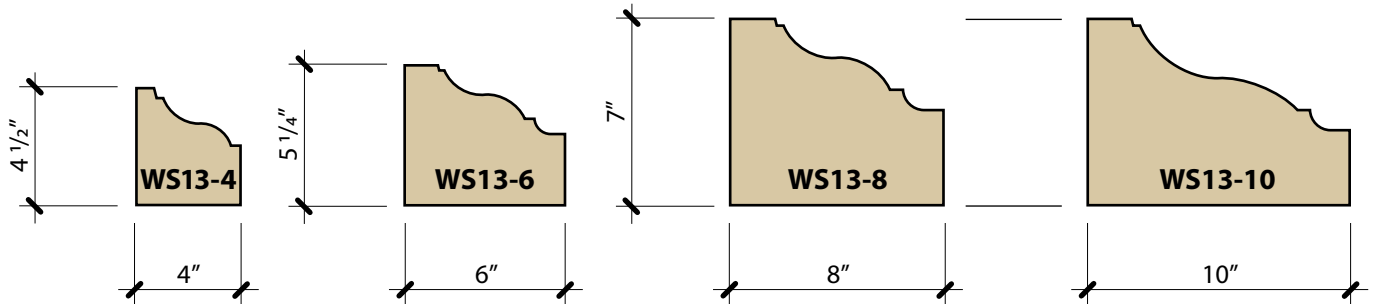

WS14



WS14-8

Refer to page 49 for window sills options

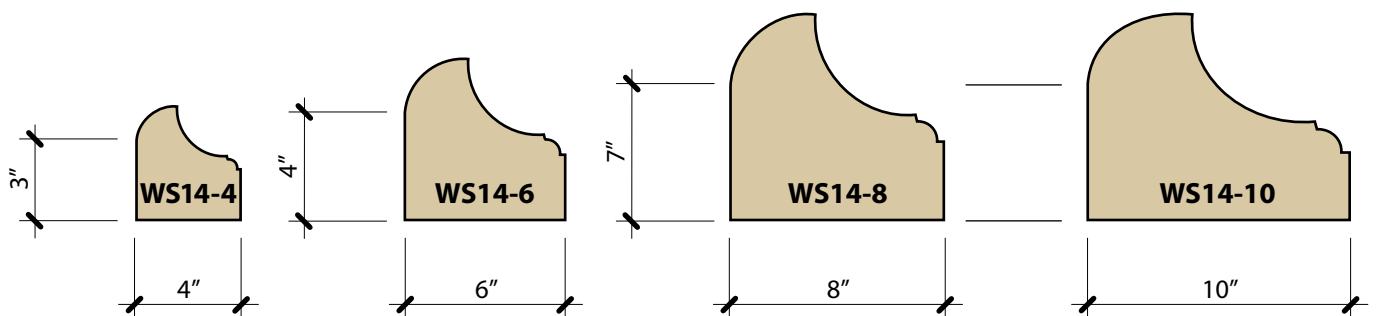

Custom sizes and styles are available. Please ask for details.

SURROUNDS — DOORS & WINDOWS

WS15



WS15-8

Refer go to page 49 for window sills options

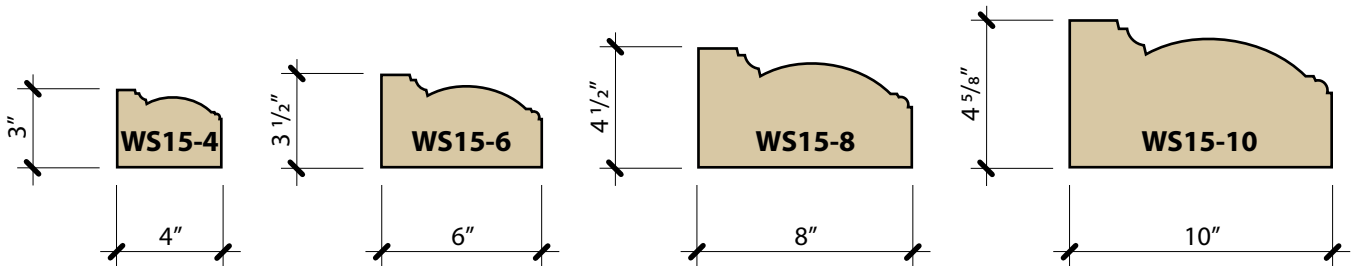

WS16

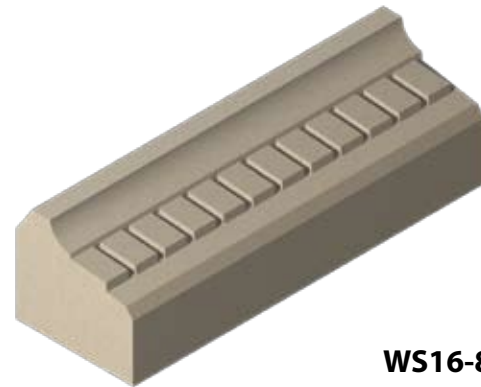
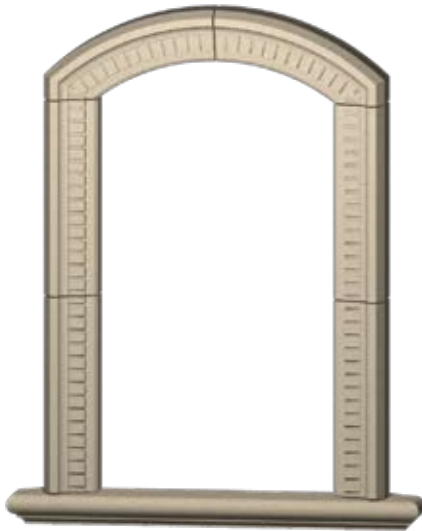

WS16-8

Refer to page 49 for window sills options

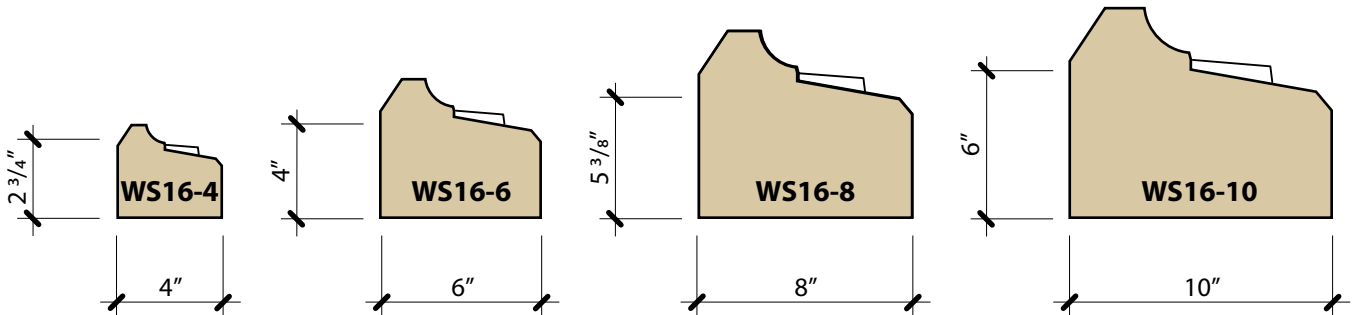

Custom sizes and styles are available. Please ask for details.

ARCHITECTURAL *Cast Stone*

Placing an Order

Our pledge “Experience the Solution” exemplifies what we are capable of doing to make the process as simple as possible for you. Just send us what you have.

If you have a set of construction documents (set of plans), then that will do. If not, send us what you have. Perhaps you are involved in the restoration of an historical building that is older than paper, send us your sketches, photographs or hand drawings. We'll work from there.

Generally that's all we need to provide you with a preliminary consultation and estimate. If we have questions, we'll contact you. Remember: Accurate dimensions are the key for accurate estimates.

How to send us your documents

Email is faster, economical and often easier. Send us CAD files, sketches and photos in almost any format. We'll reply with a confirmation and a few questions to clarify the scope of the project, shortly after, you'll receive our proposal. NASC submits detailed, itemized proposals. The proposal will allow you to have a clear idea of what's included in the project. In many cases, we provide alternative proposals as recommendations or as suitable replacements.

For additional information regarding our entire line of products, services, and highly skilled installers, please contact us at **972-562-9992** or email us at info@northamericanstone.com You may also visit us on the internet at www.northamericanstone.com

Please email plans for estimating to plans@northamericanstone.com
In most cases, our estimating department can perform your estimate within 48 hours, whether you are hard bidding or simply establishing a budget.

Experience the Solution!

www.northamericanstone.com



NORTH AMERICAN
STONE COMPANY

P.O. Box 2300
McKinney, TX 75070-8168
972.562.9992 Office
972.562.0794 Fax
info@northamericanstone.com

www.northamericanstone.com